

Intelligent HEAT

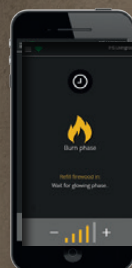

HWAM® SmartControl™



Save money
Help the environment
Sublime comfort

hwam 

Made in Denmark 







Contents

- 4** A world sensation - HWAM® SmartStove™
- 8** New: HWAM 4510, HWAM 4520
- 10** A stove is a furniture piece
- 12** HWAM 4500
- 14** HWAM 4600
- 16** HWAM 2600
- 18** HWAM I 30
- 20** HWAM 3600, white
- 22** HWAM 3600
- 24** HWAM 7100
- 26** A timeless collaboration
- 27** Modern nostalgia / HWAM Classic
- 28** HWAM 3500
- 30** Fire away - wood
- 32** HWAM 3110, white
- 34** Complete the cosy mood - accessories
- 36** Design your own wood-burning stove
- 38** Why choose HWAM

Technical specifications

- 42** HWAM 2610, HWAM 2620
- 43** HWAM 2630, HWAM 2640
- 44** HWAM 3110
- 45** HWAM 3120, HWAM 3130
- 46** HWAM 3220
- 47** HWAM 3520
- 48** HWAM 3530
- 49** HWAM 3630, HWAM 3640
- 50** HWAM 3650
- 51** HWAM 3660
- 52** HWAM 4510, HWAM 4520
- 53** HWAM 4530, HWAM 4540
- 54** HWAM 4550, HWAM 4560
- 55** HWAM 4620, HWAM 4640
- 56** HWAM 4660
- 57** HWAM 7150, HWAM 7180
- 58** HWAM I 30/55, HWAM I 30/55s
- 59** HWAM I 30/65
- 60** HWAM Classic 4
- 61** HWAM Classic 7H
- 62** Product overview
- 64** Distance to inflammable materials
- 65** Approvals
- 66** Test results

HWAM® SmartStove™

- A whole new class of wood-burning stoves

Danish craftsmanship for more than 40 years

Want to reduce your heating bills and help the environment while creating a cosy atmosphere in your living room? If so, welcome to HWAM. For over 40 years we have been creating modern Danish stoves of the highest quality.

We make it easy to fire up and spread warmth and joy. But we also care about the environment. Our newest technology utilises the firewood twice as well, saving you up to 50 percent. This way you spare the environment and your surroundings. On your mobile or tablet you can determine how hot you want the room to be. You get a reminder when you need to fill up with firewood.

We call this solution a HWAM® SmartStove™ and the technology is a global breakthrough. It is easy to use and it is called HWAM® SmartControl™.

This is a refinement of our loyal HWAM® Autopilot™ that has been the market's best mechanical air regulation for the past 25 years.

Whether you have our standard HWAM® Autopilot™ or opt for HWAM® SmartControl™, choosing HWAM means that your stove will always be eco-friendly.

Award-winning Danish technology

The technology behind HWAM® SmartControl™ is so outstanding that the Confederation of Danish Industry (DI) 2016 declared it to be a digital front-runner and nominated it for the annual DI Award - which we proudly won in September 2016.

The technology has received a number of other distinctions in the past, including gold and bronze medals at the French Bois Energie Fair, a nomination for the CSR Environment Prize awarded by the Danish Environmental Protection Agency and a nomination by the U.S. non-profit organisation Alliance of Green Heat.

WINNER OF

DI PRISEN 2016



Nominated for
CSR AWARDS 2012



HWAM is Danish craftsmanship at its very best

HWAM is entirely Danish. Our wood-burning stoves are designed by recognised Danish architects and furniture designers. Our design is simple, elegant and timeless. Danish engineers design our technology and all vital components are manufactured at our high-tech production plant in Hørning, Aarhus. We take pride in our craftsmanship.

Save money - HWAM cuts down your heating bill

Help the environment - HWAM is environmentally friendly

Sublime comfort - HWAM does the work for you

Welcome to HWAM 

Vagn Hvam Pedersen
Founder

Stefan Hvam Pedersen
CEO

Torsten Hvam Sølund
Development Manager



World-Class Innovation HWAM® SmartStove™

- A whole new class of wood-burning stoves

HWAM's automatic air regulation gives you comfort, a greener environment and a stove that's easy on the pocket.

We have developed two different solutions: HWAM® Autopilot™, which is the standard equipment for your HWAM® wood-burning stove – and HWAM® SmartControl™.

HWAM® Autopilot™

With its heat-sensitive spring, HWAM® Autopilot™ automatically ensures the exact right air supply for the different combustion phases. A mechanical solution for optimal combustion.

HWAM® SmartControl™

HWAM® SmartControl™ is our new electronic solution for combustion control. You can set your desired room temperature level with an app on your mobile or tablet. The amount of air is controlled electronically by an airbox that ensures optimal air distribution.

The app also reminds you when it's time to fill up with firewood.



Save money



Help the environment



Sublime comfort

SmartControl™



Standard

or

SmartControl™

Autopilot™

SmartControl™

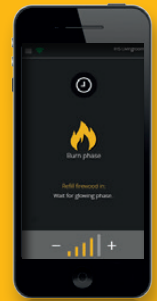

Mechanical regulation

Electronic regulation

- Fuel: up to 40% less firewood
- Generates savings: From approx. 65 to 320 Euro per year*

- Fuel: up to 50% less firewood
- Generates savings: From approx. 85 to 400 Euro per year*

- HWAM® Autopilot™ ensures a good combustion

- Guarantees the best and most eco-friendly combustion
- Option for automatic night reduction, which turns down the fire and extends the heat in the form of embers in an eco-friendly fashion

- Longer burning time

- Even longer burning time
- Easy regulation of temperature levels using an app on your mobile or tablet
- Easy to stoke and fire up
- Beeps when you need to fill up with firewood
- Generates an even temperature in the room
- Option for logging combustion data
- Continuous updates to ensure that all functions and thus your wood-burning stove as a whole get better and better with time

* All calculations are based on comparison with a corresponding HWAM® wood stove without HWAM® Autopilot™/HWAM® SmartControl™.

This is how easy it is

Light the fire as usual

With HWAM® SmartControl™, you light the fire as you would with any other stove. No changes here.

Set the desired temperature level in the room

Use the app on your phone or tablet to set the desired room temperature level with the push of a button. The solution allows you to easily and quickly control the desired temperature level in the room.

Get a reminder when you need to add more firewood

The app will tell you when it's time to add more firewood to

the stove. This way you don't have to constantly keep an eye on the fuel level in the stove – HWAM® SmartControl™ does that for you.

You save even at night...

Your wood-burning stove can now automatically minimise combustion during the night and not only give you a nice and comfortable good night's sleep, but also help you save money and protect the environment.

It doesn't get any easier.

NEW



hwam

4510m

A beautiful stove that both wall mounted and on a plinth, completing the interior design of every home.

Design: Henrik Sørig Thomsen and Tobias Jacobsen



HWAM 4520c



HWAM 4510m
wall mounted
HWAM® SmartControl™



HWAM 4510c
with low plinth
HWAM® Autopilot™



HWAM 4520m
with high plinth

Combustion systems



HWAM® SmartControl™
Only wall mounted or on a plinth

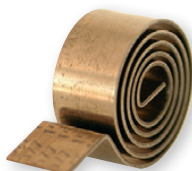

HWAM® Autopilot™

Design

A stove
is a furniture
piece

A black and white photograph of two men in a workshop. The man on the left is wearing a dark shirt and holding a glass. The man on the right is wearing a jacket and a cap. They are standing in a room with a desk, a lamp, and a circular collage on the wall. The background shows a white door and wooden beams.

"We bring the historical fireplace into the modern home. For us a wood-burning stove is a piece of furniture on par with a sofa or dining table," explains Henrik Sørig Thomsen, who has been designing HWAM stoves with Tobias Jacobsen since 2001.



A black cylindrical shape with a glass window

Over time the wood-burning stove has developed an almost iconic appearance which is consistent across nations and cultures. For the Sørig and Jacobsen Danish design duo, stove design is primarily about finding a balance between the familiar iconic appearance and surprising details. The details which make HWAM's stoves unique – both visually and functionally.

World-class combustion with a Scandinavian design

While HWAM's engineers develop the technology to ensure world-class combustion, Sørig and Jacobsen make sure that the visual details complement the functionality and simple operation.

"When children draw black smoke coming out of the chimney of a house it is quite a misconception. Wood combustion is actually very eco-friendly in terms of carbon emissions if done properly. With HWAM's technologies, we may as well begin teaching our children to draw transparent smoke, because it will never be easier to ensure correct combustion than it is with HWAM®Auto-pilot™ or HWAM® SmartControl™. It is important that our design reflects this transparent smoke. We have to show the simplicity and purity, while also producing a stove which looks attractive and is pleasant to touch," explains Henrik Sørig Thomsen.

Our stoves are like Danish chairs in this respect. The classic chairs by Danish furniture designers Hans J. Wegner and Arne Jacobsen have become world-famous because they unite discreet Scandinavian design with extraordinary comfort. In the same way, a stove from HWAM has to radiate discreet Danish design and extraordinarily high quality.

Working closely with production

"The flame presentation is critical for us. The flame is like a small painting which has to calmly create the perfect experience of atmosphere and warmth. The way the flames are framed has to highlight the painting in a very warm and discreet way," says Tobias Jacobsen. An attractively presented flame does not happen automatically. It is dependent on internal and external details, and ingenious functions such as HWAM's glass air wash to ensure the clearest picture. Sørig and Jacobsen therefore work closely with HWAM's production, and the two designers agree that it is essential for production to be based in Denmark in order to develop the best wood-burning stoves.





hwam

4560 m

The bonfire of the times of yore has gradually turned into an environmentally friendly and modern source of heat.

Design: Henrik Sørig Thomsen and Tobias Jacobsen



HWAM 4530c



HWAM 4540c
with soapstone cover



HWAM 4550m

Combustion systems



HWAM® SmartControl™

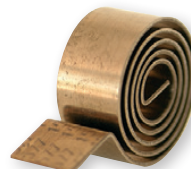

HWAM® Autopilot™



HWAM 17/18

S14

hwam

4660m

Its friendly shape provides a delightful frame around the crackling flames.

Design: Henrik Sørig Thomsen and Tobias Jacobsen



HWAM 4620c



HWAM 4640m
with soapstone cover



HWAM 4660c

Combustion systems



HWAM® SmartControl™
Not HWAM 4620

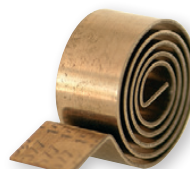

HWAM® Autopilot™





hwam

2610c

With its light and classic shape, this wall mounted stove can fit into every home.

Design: Henrik Sørig Thomsen and Tobias Jacobsen



HWAM 2620c



HWAM 2630c



HWAM 2640m

Combustion systems



HWAM® SmartControl™

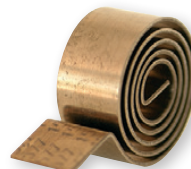

HWAM® Autopilot™



HWAM 17/18

S18

hwam

I 30/55

Get vibrant art on the wall - it never goes out of fashion.

Design: Henrik Sørig Thomsen and Tobias Jacobsen



HWAM I 30/55



HWAM I 30/65

Combustion system

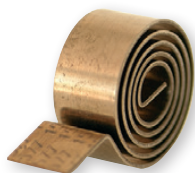

HWAM® Autopilot™



hwam

3660m

A modern classic is born. Innovative Danish design meets exclusive Nordic minimalist elegance.

- Welcome to our world of white!

Design: Henrik Sørig Thomsen and Tobias Jacobsen



HWAM 3630m



HWAM 3640m



HWAM 3650m

Combustion systems



HWAM® SmartControl™

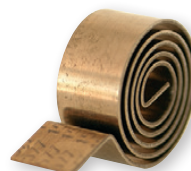

HWAM® Autopilot™



hwam

3660 m

The minimalist exterior conceals advanced technology:
The heat storage compartment accumulates heat and
releases it evenly over several hours.

Design: Henrik Sørig Thomsen and Tobias Jacobsen



HWAM 3630m



HWAM 3640c
with soapstone cover



HWAM 3640c



HWAM 3650m

Combustion systems



HWAM® SmartControl™

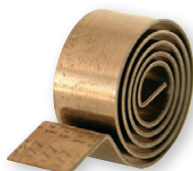

HWAM® Autopilot™



hwam

7150c

A beautiful and solid sculpture in the living room, emitting heat long after the fire is out.

Design: Henrik Sørig Thomsen and Tobias Jacobsen



HWAM 7180c
with soapstone cover

Combustion systems



HWAM® SmartControl™

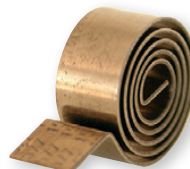

HWAM® Autopilot™



A timeless collaboration

The idea that form follows function has always been a foundational pillar in architect and cabinetmaker Anders C. FASTERHOLDT's design work. This is a key concept that he and HWAM's founder, Vagn Hvam Pedersen, have transferred to HWAM's stoves during his more than 35 years of regular and indispensable service to the Hørning-based company. "For me, the function is central. I have always said: First consider the function, and the design will follow automatically. Doing design for the sake of design is not me."

Modern nostalgia

HWAM
Classic 4





HWAM 17/18

S28

3530m

HWAM 3530 is a stove of medium height. Here shown with a beautiful stone cover for long-lasting heat.

Design: Architect Anders C. FASTERHOLDT



HWAM 3520c



HWAM 3520m



HWAM 3530c

Combustion systems



HWAM® SmartControl™

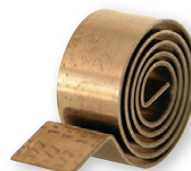

HWAM® Autopilot™

FIRE AWAY!

**Are you giving it any thought
what sort of wood you are using?
If not, we recommend you consider
doing that. There is namely a mas-
sive difference between the calorific
values of different wood sorts.**



Pine Wood

Pine is easy to light. It burns quickly with a fantastic bright flame and produces only a few embers. The same is true of spruce.



Oak Wood

Oak requires a high temperature, but once the fire has taken hold, the wood has a long combustion and ember time. It produces atmospheric coals and crackles merrily.



Beech Wood

Beech wood requires a high temperature, but is ideal firewood which provides good heat and atmospheric embers.



Birch Wood

Birch is a lighter wood and is good for lighting, as it catches easily and heats well. It does not produce much smoke, but burns with attractive flames and a wonderful aroma. The same is true for lime and chestnut wood.

How do you store your wood?

Have you ever given thought to where and how you store your firewood?

If not, you should. The way you store your wood does matter, as it is to have a moisture level of no more than 18%. The wood can seem dry on the outside but still be moist inside if it is dried in an oven. It is therefore preferable to dry firewood naturally outside in the sun and wind. It is important to store it where it is exposed to sun and wind, and not on the ground, but stacked under a roof which keeps off the rain.

It can take around six months to completely dry firewood outdoors. It is a good idea to fell trees for firewood during autumn and winter, as they contain less sap at this time.

If firewood is not handled correctly it can develop rot or remain moist for several seasons. It is therefore important to be careful about how you store your firewood. Some people think firewood is dry if it is two years old. You cannot be sure of this if it has been handled incorrectly.





3110m

With its oval shape, this small wall mounted stove floats in the room.

Design: Architect Anders C. FASTERHOLDT



HWAM 3110c



HWAM 3120m



HWAM 3130c

Combustion systems



HWAM® SmartControl™
Not HWAM 3110

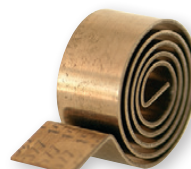

HWAM® Autopilot™

Complete

the cosy mood

created by your stove with the right accessory



From top to toe

Now, as a brand new offer, you can buy tailored floor plates for your HWAM wood-burning stove.

We have developed new floor plates in steel and glass that are tailored exactly to the shape of your stove. The floor plates have a practical shape, are easy to remove during cleaning and are simultaneously a good aesthetic match for every style of interior decoration.



HWAM firewood trolley

The original HWAM firewood trolley is a practical and rugged assistant to help transport firewood to your stove. The elegant design matches all of our stoves.

Design: Architect Anders C. FASTERHOLDT.



HWAM firewood bucket

The HWAM firewood bucket is a classic, rugged firewood holder designed to match our classic stoves.

Design: Architect Anders C. FASTERHOLDT.



Presence

Design

your own wood-burning stove

Find your HWAM

We offer so many designs that you can easily find the wood-burning stove that would fit perfectly in your home.

At HWAM, you can design your own stove. See the components and colours to choose from below:



Classic or modern door?

Choose from two beautiful door styles, Classic and Modern.

Classic doors (c) are with a classic design look: A cast iron frame encompasses the large pane of the stove door.

Modern doors (m) have a more modern look with glass on an invisible cast iron frame.



White HWAM

Want to stand out from the crowd? We offer seven models in white, namely HWAM 3110m, 3120m, 3130m, 3630m, 3640m, 3650m and 3660m.

Wall mounted, on a pedestal or on a plinth

Furthermore the HWAM 2610, 2620, 3110, 4510, and 4520 can be wall mounted or placed on either a pedestal or a plinth.

Use stone cladding for longer-lasting heat

Would you like to prolong the heating effect while keeping up with the raw material building trend? Then you should choose a HWAM wood burning stove with stone cladding.

A wide range of our stoves can be delivered with natural stone: Sandstone in Tobacco and Grey, or soapstone. Stone is a natural material, so each stove has a raw stone look that is quite unique.



Grey sandstone



Soapstone



Tobacco sandstone

Long-lasting heat

Do you want to keep the heat longer? Then you should choose a HWAM wood burning stove with heat storage compartment. Here we combine the rapid convection heat of the wood-burning stove with the capacity to accumulate heat of the Russian oven.

Fill up the heat storage compartment with stone, which accumulates the heat generated by the stove, slowly emit-

ting it to the room - even long after the fire has gone out. Heat accumulation stones keep warm for up to 10 hours after the last firing.

The heat storage compartment is equipped with a control handle, so you can regulate whether to distribute the heat quickly into the room or to keep it in the heat store compartment to be released slowly over a prolonged period once the fire has burnt out.

Why choose
HWAM?



- **Made in Denmark**

All HWAM stoves are designed and manufactured in Denmark.

- **HWAM® Autopilot™ does all controlling for you**

All HWAM stoves are supplied with HWAM® Autopilot™, which regulates the air supply automatically, so that you get more out of your firewood.

- **Save on firewood**

If you would like to get twice as much out of your firewood, you can buy HWAM® SmartControl™ - a global innovation in the field of intelligent wood-burning stove control.

- **Always updated!**

If our skilled engineers find optimisations for the HWAM® SmartControl™ system, you can download the newest version in App Store or Google Play Store, in order to have the newest and best, intelligent control for your stove.

- **How warm would you have it?**

A HWAM wood-burning stove with HWAM® SmartControl™ gives you total control. This way the room temperature level is exactly what you want it to be.

- **Nice view of the flames with air wash system**

All HWAM stoves are equipped with an air wash system which guarantees you a nice view of the flames.

- **Unique closing system**

All HWAM stoves have an easy and unique closing system, which ensures that the door fits tightly.

- **A straight stove on a crooked floor**

Even if your floor is crooked, it is easy to get your HWAM wood-burning stove to stand straight. We call this system "adjustment feet", because the feet can be adjusted.

- **Fresh air system, ensuring optimal air supply**

The fresh air system ensures constant supply of the required amount of exterior air. For easy lighting, great combustion conditions and optimal heat utilisation. An eco-friendly solution, ideal for low energy houses.

- **Approved in all ways**

All of our wood-burning stoves are in compliance with the most rigorous of European requirements.

- **Floor plate in steel or glass**

To spare the floor in front of your stove, we offer customised floor plates. They are easy to remove and clean. Choose between steel and glass, so you get the best solution that is perfect for your home.



The background is a solid yellow color with faint, light-colored technical drawings overlaid. On the left, there is a vertical cross-section of a mechanical assembly, showing various components like a shaft, housing, and bearings. In the upper right, there is a circular detail view showing a close-up of a component with a textured surface. A diagonal hatched area runs from the top left towards the bottom right, representing a section cut in a drawing.

Technical

data

Technical data

Capacity	2-6 kW
Nominal heat output	4.5 kW
Smoke outlet	Ø 150 mm
Net efficiency Autopilot™/ SmartControl™	80/81%
Chimney draught, min. (recommended)	12 Pa
Energy efficiency class Autopilot™/SmartControl™	A+/A+

Weight

Weight HWAM 2610c/2610m	66/64 kg
Weight HWAM 2620c/2620m	66/64 kg
Weight pedestal	15 kg

Measurements

Width of combustion chamber	27,0 cm
Connection from floor with Autopilot™*, top	65,1 cm
Connection from floor with SmartControl™*, top	67,8 cm
Connection from floor on plinth, top	68,1 cm
Connection from floor on plinth, SmartControl™, top	70,8 cm
Connection from floor on pedestal, Autopilot™, top	95,1 cm
Connection from floor on pedestal, SmartControl™, top	97,8 cm
Connection from wall to center of top outlet, wall mounted	18,9 cm

* From the lower edge of the stove without plinth

Variants

- Autopilot™ or SmartControl™
- Classic door (c) or modern door (m)
- Cast iron top, top outlet or back outlet
- Pedestal, plinth or wall mounted

Accessories

- Combustion air system back/bottom



HWAM 2610c with side glasses and plinth



HWAM 2610m with side glasses



HWAM 2620c on pedestal

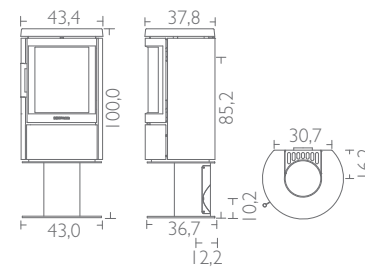
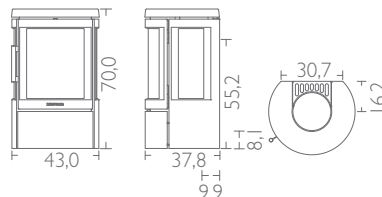
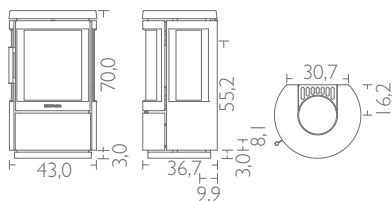

HWAM 2630 HWAM 2640

Technical data

Capacity	2-6 kW
Nominal heat output	4,5 kW
Smoke outlet	Ø 150 mm
Net efficiency Autopilot™/ SmartControl™	80/81%
Chimney draught, min. (recommended)	12 Pa
Energy efficiency class Autopilot™/SmartControl™	A+/A+

Weight

Weight HWAM 2630c/2630m	75/73 kg
Weight HWAM 2640c/2640m	75/73 kg

Measurements

Width of combustion chamber	27,0 cm
Connection from floor with Autopilot™, top	95,1 cm
Connection from floor with SmartControl™, top	97,8 cm

Variants

- Autopilot™ or SmartControl™
- Classic door (c) or modern door (m)
- Cast iron top, top outlet or back outlet

Accessories

- Combustion air system back/bottom



HWAM 2630c with side glasses



HWAM 2640c



HWAM 2640m

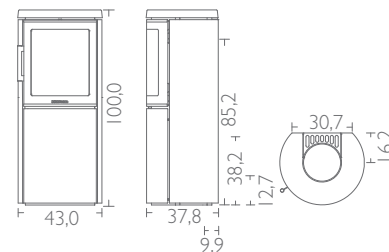
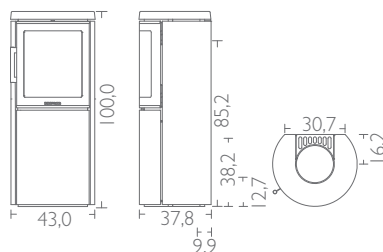
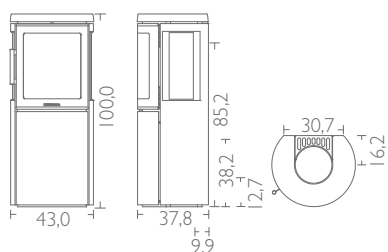

SPECIFICATIONS #17/18

All drawings: The measurements for the flue outlet and fresh air connection have been given to the centre of the hole.

HWAM 3110

Technical data

Capacity	2-7 kW
Nominal heat output	4,5 kW
Smoke outlet	Ø 150 mm
Net efficiency Autopilot™	78%
Chimney draught, min. (recommended)	12 Pa
Energy efficiency class Autopilot™	A

Weight

Weight HWAM 3110c/3110m	87/84 kg
Weight pedestal	14 kg

Measurements

Width of combustion chamber	33,0 cm
Connection from floor with Autopilot™*, top	69,8 cm
Connection from floor on plinth, top	72,8 cm
Connection from floor on pedestal, Autopilot™, top	99,8 cm
Connection from wall to center of top outlet, wall-mounted	20,5 cm

* From the lower edge of the stove without plinth

Variants

Autopilot™

Classic door (c) or modern door (m)

Cast iron top, top outlet or back outlet

Pedestal, plinth or wall-mounted

HWAM 3110m is also available in white steel

Accessories

Combustion air system back/bottom



HWAM 3110c with plinth



HWAM 3110m, white



HWAM 3110m on pedestal

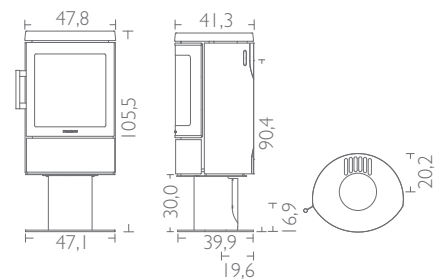
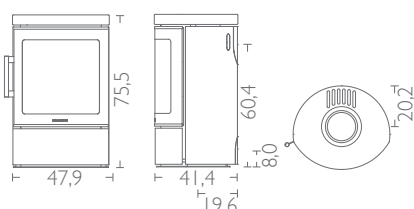
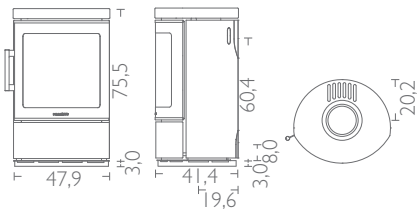

HWAM 3120

HWAM 3130

Technical data

Capacity	2-7 kW
Nominal heat output	4,5 kW
Smoke outlet	Ø 150 mm
Net efficiency Autopilot™/ SmartControl™	78/83%
Chimney draught, min. (recommended)	12 Pa
Energy efficiency class Autopilot™/SmartControl™	A/A+

Weight

Weight HWAM 3120c/3120m	107/104 kg
Weight HWAM 3130c/3130m	113/110 kg
Weight, heat storage stones	Ca. 32 kg

Measurements

Width of combustion chamber	33,0 cm
Connection from floor with Autopilot™, top	94,8 cm
Connection from floor with SmartControl™, top	97,5 cm

Variants

- Autopilot™ or SmartControl™
- Classic door (c) or modern door (m)
- Cast iron top, top outlet or back outlet
- HWAM 3120m and 3130m are also available in white steel

Accessories

- Combustion air system back/bottom
- Heat storage stones (HWAM 3130)



HWAM 3120c



HWAM 3120m, white



HWAM 3130m

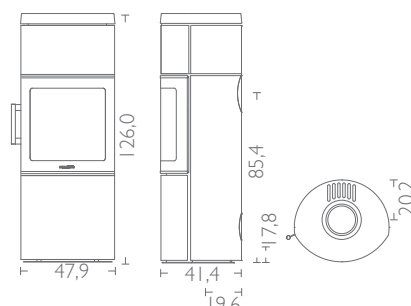
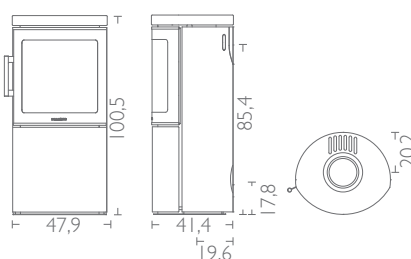
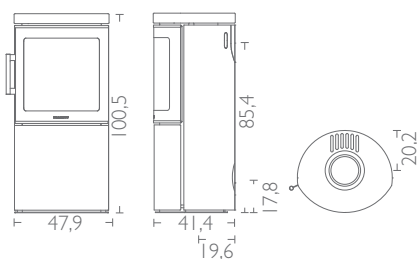

SPECIFICATIONS #17/18

All drawings: The measurements for the flue outlet and fresh air connection have been given to the centre of the hole.

hwam 3220

Technical data

Capacity	2-7 kW
Nominal heat output	4,5 kW
Smoke outlet	Ø 150 mm
Net efficiency Autopilot™/SmartControl™	78/83%
Chimney draught, min. (recommended)	12 Pa
Energy efficiency class Autopilot™/SmartControl™	A/A+

Weight

Weight HWAM 3220c/3220m	91/88 kg
-------------------------	----------

Measurements

Width of combustion chamber	33,0 cm
Connection from floor with Autopilot™, top	94,8 cm
Connection from floor with SmartControl™, top	97,5 cm

Variants

Autopilot™ or SmartControl™
Soapstone top, top outlet or back outlet
Classic door (c) or modern door (m)

Accessories

Combustion air system back/bottom



HWAM 3220c



HWAM 3220m

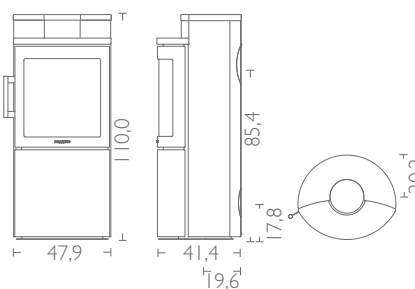

HWAM 3520

Technical data

Capacity	2-7 kW
Nominal heat output	4,5 kW
Smoke outlet	Ø 150 mm
Net efficiency Autopilot™/SmartControl™	78/83%
Chimney draught, min. (recommended)	12 Pa
Energy efficiency class Autopilot™/SmartControl™	A/A+

Weight

Weight HWAM 3520c/3520m	118/115 kg
Weight with soapstone cover HWAM 3520c/3520m	167/164 kg
Weight with sandstone cover HWAM 3520c/3520m	155/152 kg
Weight, heat storage stones	Ca. 44 kg

Measurements

Width of combustion chamber	33,0 cm
Connection from floor with Autopilot™, top	95,0 cm
Connection from floor with SmartControl™, top	97,7 cm

Variants

- Autopilot™ or SmartControl™
- Classic door (c) or modern door (m)
- Cast iron top, top outlet or back outlet
- Soapstone cover, top outlet or back outlet
- Sandstone cover, top outlet or back outlet

Accessories

- Combustion air system back/bottom
- Heat storage stones



HWAM 3520c



HWAM 3520m



HWAM 3520c with grey sandstone cover

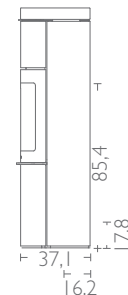
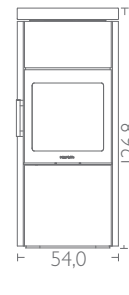
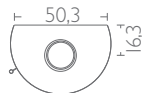
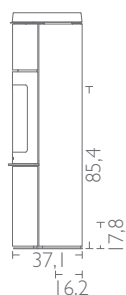
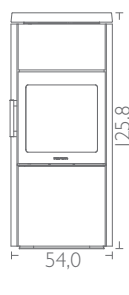
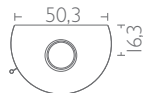
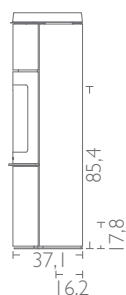
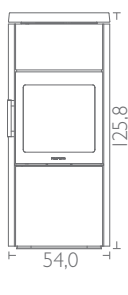

All drawings: The measurements for the flue outlet and fresh air connection have been given to the centre of the hole.

SPECIFICATIONS #17/18

HWAM 3530

Technical data

Capacity	2-7 kW
Nominal heat output	4,5 kW
Smoke outlet	Ø 150 mm
Net efficiency Autopilot™/SmartControl™	78/83%
Chimney draught, min. (recommended)	12 Pa
Energy efficiency class Autopilot™/SmartControl™	A/A+

Weight

Weight HWAM 3530c/3530m	131/128 kg
Weight with soapstone cover HWAM 3530c/3530m	191/188 kg
Weight with sandstone cover HWAM 3530c/3530m	178/175 kg
Weight, heat storage stones	Ca. 77 kg

Measurements

Width of combustion chamber	33,0 cm
Connection from floor with Autopilot™, top	95,0 cm
Connection from floor with SmartControl™, top	97,7 cm

Variants

- Autopilot™ or SmartControl™
- Classic door (c) or modern door (m)
- Cast iron top, top outlet or back outlet
- Soapstone cover; top outlet or back outlet
- Sandstone cover; top outlet or back outlet

Accessories

- Combustion air system back/bottom
- Heat storage stones



HWAM 3530c

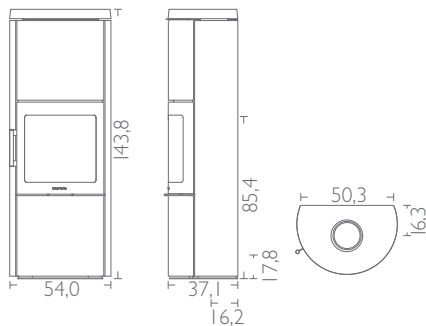

HWAM 3530c with soapstone cover

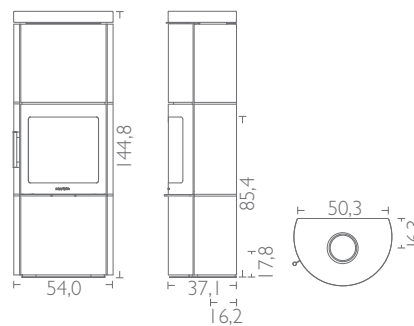

HWAM 3630

HWAM 3640

Technical data

Capacity	3-9 kW
Nominal heat output	6,0 kW
Smoke outlet	Ø 150 mm
Net efficiency Autopilot™	78/81%
Chimney draught, min. (recommended) Autopilot™/SmartControl™	11/12 Pa
Energy efficiency class Autopilot™/SmartControl™	A/A+

Weight

Weight HWAM 3630c/3630m	139/136 kg
Weight HWAM 3640c/3640m	139/136 kg
Weight with soapstone cover HWAM 3640c/3640m	229/226 kg
Weight with sandstone cover HWAM 3640c/3640m	211/208 kg

Measurements

Width of combustion chamber	35,0 cm
Connection from floor with Autopilot™, top	109,6 cm
Connection from floor with SmartControl™, top	112,3 cm

Variants

- Autopilot™ or SmartControl™
- Classic door (c) or modern door (m)
- Cast iron top, top outlet or back outlet
- Soapstone cover; top outlet or back outlet (HWAM 3640)
- Sandstone cover; top outlet or back outlet (HWAM 3640)
- HWAM 3630m and 3640m are also available in white steel

Accessories

- Combustion air system back/bottom



HWAM 3630c with side glasses



HWAM 3640c with soapstone cover



HWAM 3640m, white

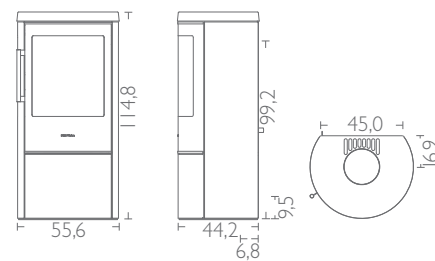
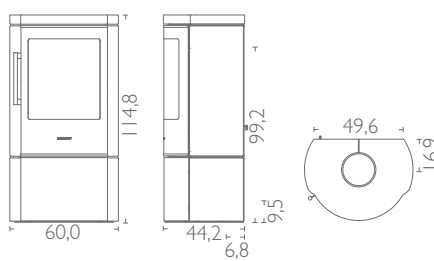
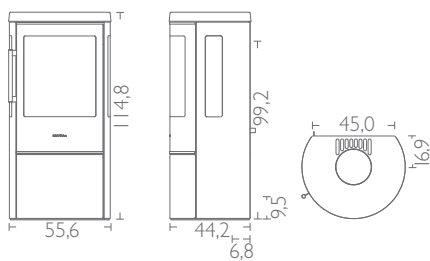

All drawings: The measurements for the flue outlet and fresh air connection have been given to the centre of the hole.

hwam 3650

Technical data

Capacity	3-9 kW
Nominal heat output	6,0 kW
Smoke outlet	Ø 150 mm
Net efficiency Autopilot™/ SmartControl™	78/81%
Chimney draught, min. (recommended) Autopilot™/ SmartControl™	11/12 Pa
Energy efficiency class Autopilot™/SmartControl™	A/A+

Weight

Weight HWAM 3650c/3650m	171/168 kg
Weight, heat storage stones	Ca. 55 kg

Measurements

Width of combustion chamber	35,0 cm
Connection from floor with Autopilot™, top	109,6 cm
Connection from floor with SmartControl™, top	112,3 cm

Variants

- Autopilot™ or SmartControl™
- Classic door (c) or modern door (m)
- Cast iron top, top outlet or back outlet
- HWAM 3650m is also available in white steel

Accessories

- Combustion air system back/bottom
- Heat storage stones



HWAM 3650c with side glasses



HWAM 3650m with side glasses, white

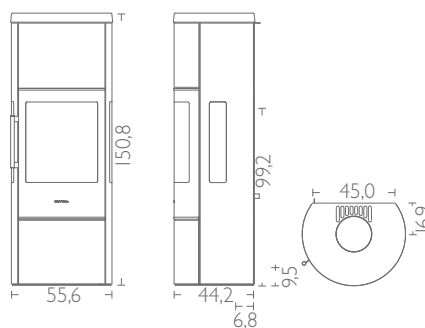
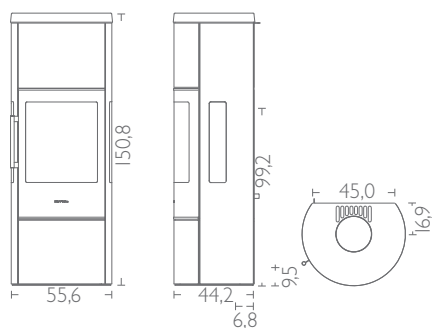

HWAM 3660

Technical data

Capacity	3-9 kW
Nominal heat output	6,0 kW
Smoke outlet	Ø 150 mm
Net efficiency Autopilot™/SmartControl™	78/81%
Chimney draught, min. (recommended) Autopilot™/SmartControl™	11/12 Pa
Energy efficiency class Autopilot™/SmartControl™	A/A+

Weight

Weight HWAM 3660c/3660m	171/168 kg
Weight with soapstone cover HWAM 3660c/3660m	282/279 kg
Weight with sandstone cover HWAM 3660c/3660m	260/257 kg
Weight, heat storage stones	Ca. 55 kg

Measurements

Width of combustion chamber	35,0 cm
Connection from floor with Autopilot™, top	109,6 cm
Connection from floor with SmartControl™, top	112,3 cm

Variants

- Autopilot™ or SmartControl™
- Classic door (c) or modern door (m)
- Cast iron top, top outlet or back outlet
- Soapstone cover; top outlet or back outlet
- Sandstone cover; top outlet or back outlet
- HWAM 3660m is also available in white steel

Accessories

- Combustion air system back/bottom
- Heat storage stones



HWAM 3660c



HWAM 3660m, white



HWAM 3660m with soapstone cover

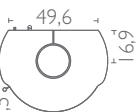
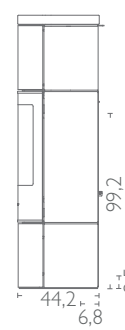
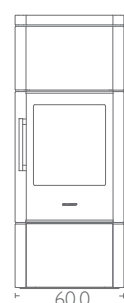
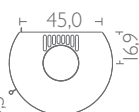
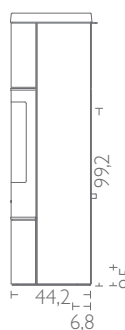
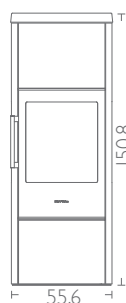
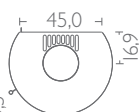
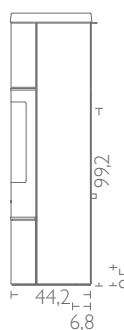
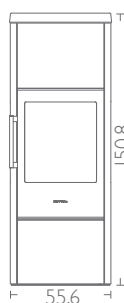

Technical data

Capacity	3-7 kW
Nominal heat output	4,9 kW
Smoke outlet	Ø 150 mm
Net efficiency Autopilot™/ SmartControl™	82/81%
Chimney draught, min. (recommended)	12 Pa
Energy efficiency class Autopilot™/SmartControl™	A+/A+

Weight

Weight HWAM 4510c/4510m	101/99 kg
Weight HWAM 4520c/4520m	96/94 kg
Weight with low plinth HWAM 4510c/4510m	105/103 kg
Weight with low plinth HWAM 4520c/4520m	100/98 kg
Weight with high plinth HWAM 4510c/4510m	109/107 kg
Weight with high plinth HWAM 4520c/4520m	104/102 kg

Measurements

Width of combustion chamber	35,8 cm
Connection from floor without plinth, top, Autopilot™*	72,3 cm
Connection from floor without plinth, top, SmartControl™*	77,8 cm
Connection from floor low plinth, top	89,8 cm
Connection from floor high plinth, top	100,8 cm
Connection from wall to center of top outlet, wall-mounted	21,3 cm

* From the lower edge of the stove without plinth

Variants

- Autopilot™ or SmartControl™ (only wall mounted or with a plinth)
- Classic door (c) or modern door (m)
- Cast iron top, top outlet or back outlet
- Low plinth, high plinth, floor model or wall mounted

Accessories

- Combustion air system back/bottom



HWAM 4520c



HWAM 4510m
wall mounted
HWAM® SmartControl™



HWAM 4510c
with low plinth
HWAM® Autopilot™



HWAM 4520m
with high plinth

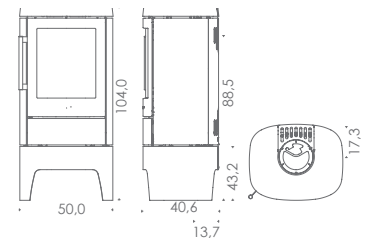
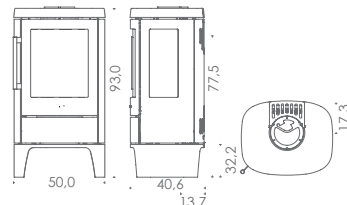
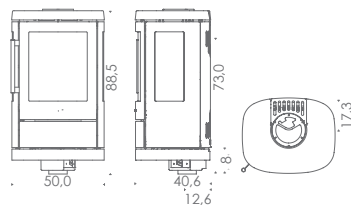
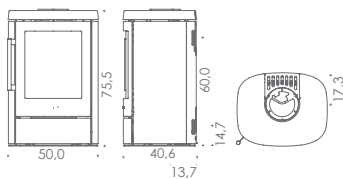

HWAM 4530 HWAM 4540

Technical data

Capacity	3-7 kW
Nominal heat output	4,9 kW
Smoke outlet	Ø 150 mm
Net efficiency Autopilot™/ SmartControl™	82/81%
Chimney draught, min. (recommended)	12 Pa
Energy efficiency class Autopilot™/SmartControl™	A+/A+

Weight

Weight HWAM 4530c/4530m	124/122 kg
Weight HWAM 4540c/4540m	119/117 kg
Weight with soapstone cover HWAM 4540c/4540m	175/173 kg
Weight with sandstone cover HWAM 4540c/4540m	136/134 kg

Measurements

Width of combustion chamber	35,8 cm
Connection from floor; top	111,4 cm

Variants

Autopilot™ or SmartControl™
Classic door (c) or modern door (m)
Cast iron top, top outlet or back outlet
Soapstone cover; top outlet or back outlet (HWAM 4540)
Sandstone cover; top outlet or back outlet (HWAM 4540)

Accessories

Combustion air system back/bottom



HWAM 4530c with side glasses



HWAM 4530m with side glasses



HWAM 4540c with soapstone cover

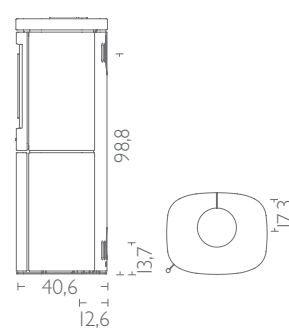
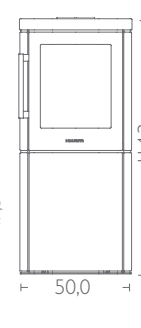
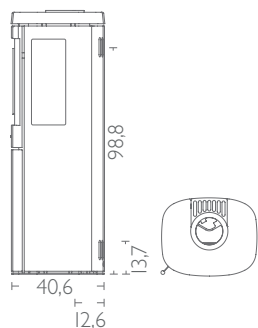
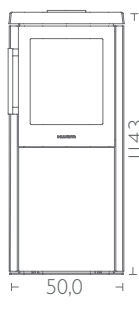
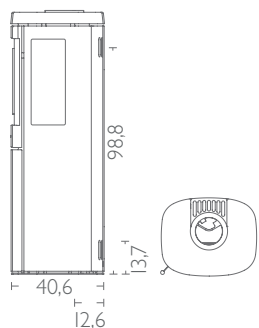
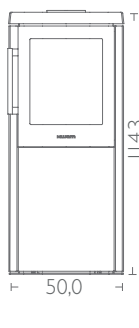

SPECIFICATIONS #17/18

All drawings: The measurements for the flue outlet and fresh air connection have been given to the centre of the hole.

HWAM 4550

HWAM 4560

Technical data

Capacity	3-7 kW
Nominal heat output	4,9 kW
Smoke outlet	Ø 150 mm
Net and Gross efficiency Autopilot™/SmartControl™	82/81%
Chimney draught, min. (recommended)	12 Pa
Energy efficiency class Autopilot™/SmartControl™	A+/A+

Weight

Weight HWAM 4550c/4550m	134/132 kg
Weight HWAM 4560c/4560m	129/127 kg
Weight with soapstone cover HWAM 4560c/4560m	201/199 kg
Weight with sandstone cover HWAM 4560c/4560m	156/154 kg
Weight, heat storage stones	Ca. 29 kg

Measurements

Width of combustion chamber	35,8 cm
Connection from floor; top	111,4 cm

Variants

- Autopilot™ or SmartControl™
- Classic door (c) or modern door (m)
- Cast iron top, top outlet or back outlet
- Soapstone cover, top outlet or back outlet (HWAM 4560)
- Sandstone cover, top outlet or back outlet (HWAM 4560)

Accessories

- Combustion air system back/bottom
- Heat storage stones



HWAM 4550m



HWAM 4560c



HWAM 4560m with soapstone cover

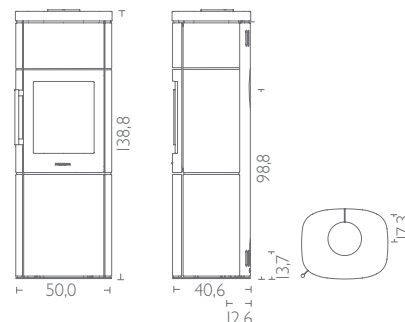
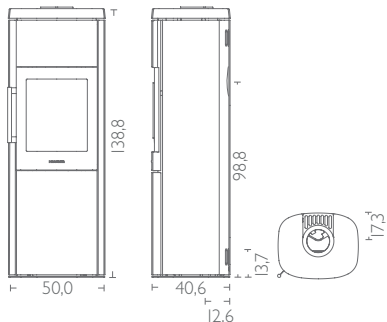
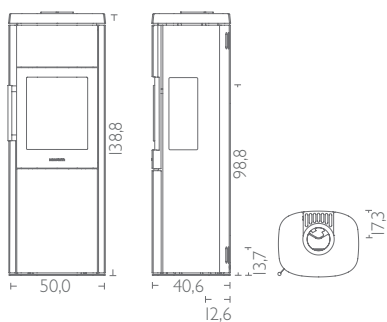

HWAM 4620 HWAM 4640

Technical data

Capacity	3-9 kW
Nominal heat output Autopilot™/SmartControl™	7,0/8,0 kW
Smoke outlet	Ø 150 mm
Net efficiency Autopilot™/ SmartControl™	80/81%
Chimney draught, min. (recommended)	12 Pa
Energy efficiency class Autopilot™/SmartControl™	A+/A+

Weight

Weight HWAM 4620c/4620m	119/117 kg
Weight HWAM 4640c/4640m	133/131 kg
Weight with soapstone cover HWAM 4640c/4640m	197/195 kg
Weight with sandstone cover HWAM 4640c/4640m	182/180 kg

Measurements

Width of combustion chamber	49,0 cm
Connection from floor; top, HWAM 4620	81,9 cm
Connection from floor; top, HWAM 4640	111,4 cm

Variants

- Autopilot™ (HWAM 4620/4640) or SmartControl™ (HWAM 4640)
- Classic door (c) or modern door (m)
- Cast iron top, top outlet or back outlet
- Soapstone cover; top outlet or back outlet (HWAM 4640)
- Sandstone cover; top outlet or back outlet (HWAM 4640)

Accessories

- Combustion air system back/bottom



HWAM 4620c



HWAM 4640m with soapstone cover



HWAM 4640m

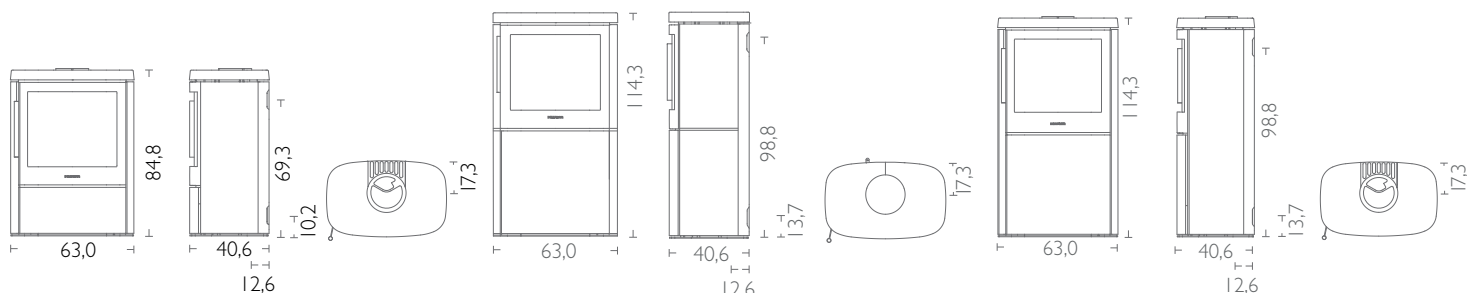

SPECIFICATIONS #17/18

hwam 4660

Technical data

Capacity	3-9 kW
Nominal heat output Autopilot™/SmartControl™	7,0/8,0 kW
Smoke outlet	Ø 150 mm
Net efficiency Autopilot™/ SmartControl™	80/81%
Chimney draught, min. (recommended)	12 Pa
Energy efficiency class Autopilot™/SmartControl™	A+/A+

Weight

Weight HWAM 4660c/4660m	153/151 kg
Weight with soapstone cover HWAM 4660c/4660m	224/222 kg
Weight with sandstone cover HWAM 4660c/4660m	209/207 kg
Weight, heat storage stones	Ca. 45 kg

Measurements

Width of combustion chamber	49,0 cm
Connection from floor; top	111,4 cm

Variants

Autopilot™ or SmartControl™
Classic door (c) or modern door (m)
Cast iron top, top outlet or back outlet
Soapstone cover; top outlet or back outlet
Sandstone cover; top outlet or back outlet

Accessories

Combustion air system back/bottom
Heat storing stone



HWAM 4660c

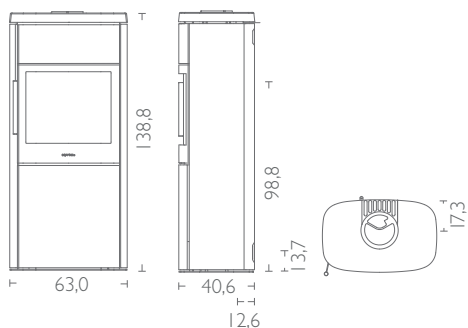

HWAM 4660m with Tobacco sandstone cover

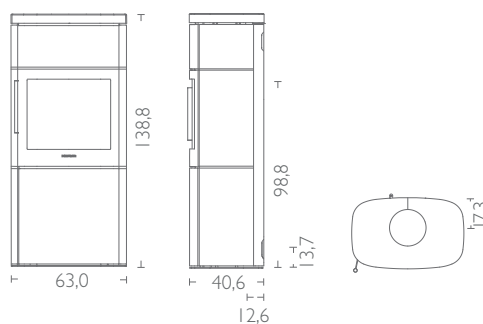

hwam 7150

hwam 7180

Technical data

Capacity	2-7 kW
Nominal heat output	4,5 kW
Smoke outlet	Ø 150 mm
Net efficiency Autopilot™/SmartControl™	81/81%
Chimney draught, min. (recommended)	12 Pa
Energy efficiency class Autopilot™/SmartControl™	A+/A+

Weight

Weight with soapstone cover HWAM 7150c/7150m	462/459 kg
Weight with soapstone cover HWAM 7180c/7180m	524/521 kg
Weight, heat storage stones HWAM 7150/7180	Ca. 50/90 kg

Measurements

Width of combustion chamber	33,0 cm
Connection from floor; top, HWAM 7150/7180	138,1/168,1 cm

Variants

- Autopilot™ or SmartControl™
- Classic door (c) or modern door (m)

Accessories

- Combustion air system back/bottom
- Heat storage stones



HWAM 7150c with soapstone cover



HWAM 7180c with soapstone cover



HWAM 7180m with soapstone cover

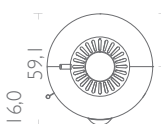
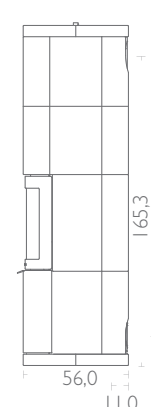
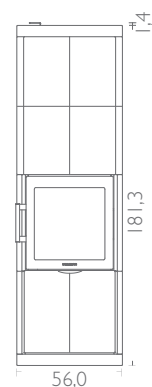
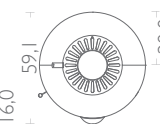
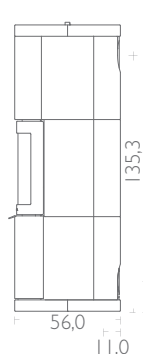
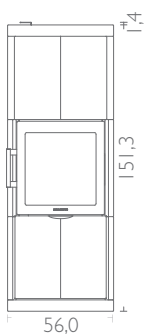

SPECIFICATIONS #17/18

All drawings: The measurements for the flue outlet and fresh air connection have been given to the centre of the hole.

Technical data

Capacity	4-10 kW
Nominal heat output	7 kW
Smoke outlet	Ø150 mm
Net efficiency Autopilot™	81%
Chimney draught, min. (recommended)	12 Pa
Energy efficiency class Autopilot™	A+

Weight

Weight HWAM I 30/55	98 kg
Weight HWAM I 30/55s	92 kg

Measurements

Width of combustion chamber	55,0 cm
-----------------------------	---------

Variants

- Autopilot™
- Lifting door (HWAM I 30/55) or side hinged door (HWAM I 30/55s)
- Top outlet or back outlet

Accessories

- Combustion air system back/bottom



HWAM I 30/55



HWAM I 30/55s



HWAM I 30/55s

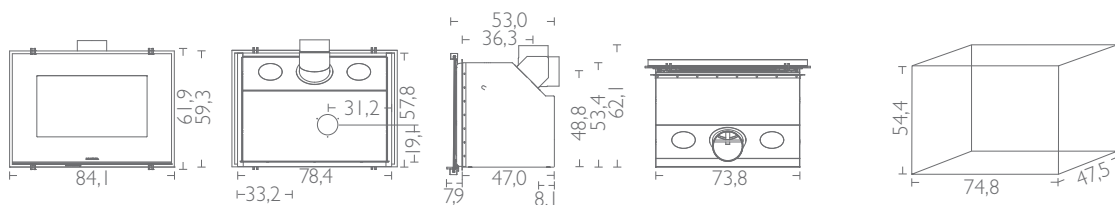

hwam | 30/65

Technical data

Capacity	6-14 kW
Nominal heat output	10 kW
Smoke outlet	Ø150 mm
Net efficiency Autopilot™	79%
Chimney draught, min. (recommended)	12 Pa
Energy efficiency class Autopilot™	A

Weight

Weight	126 kg
--------	--------

Measurements

Width of combustion chamber	81,0 cm
-----------------------------	---------

Variants

Autopilot™

Top outlet or back outlet

Accessories

Combustion air system back

Autopilot™



HWAM I 30/65

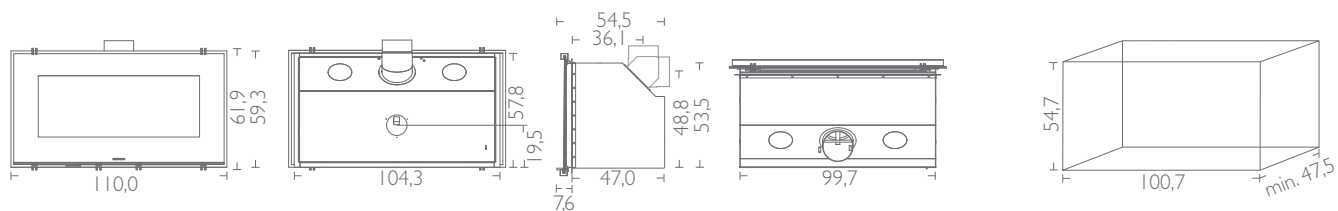

All drawings: The measurements for the flue outlet and fresh air connection have been given to the centre of the hole.

SPECIFICATIONS #17/18

S59

HWAM Classic 4

Technical data

Capacity	3-8 kW
Nominal heat output	8 kW
Smoke outlet	Ø 150 mm
Net efficiency Autopilot™	79%
Chimney draught, min. (recommended)	12 Pa
Energy efficiency class Autopilot™	A

Weight

Weight	108 kg
Weight with plinth	120 kg
Weight with baking oven	178 kg
Weight with plinth and baking oven	190 kg

Measurements

Width of combustion chamber	40,0 cm
Baking oven, H x W x D	22,5 x 46,6 x 23,7 cm
Connection from floor; top	68,7 cm
Connection from floor with plinth, top	90,7 cm
Connection from floor with baking oven, top	108,5 cm
Connection from floor with plinth and baking oven	130,5 cm

Variants

Autopilot™
Top outlet or back outlet (not with baking oven)
Plinth
Baking oven

Autopilot™



HWAM Classic 4



HWAM Classic 4 with plinth and baking oven

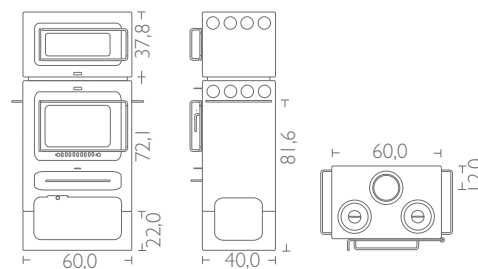
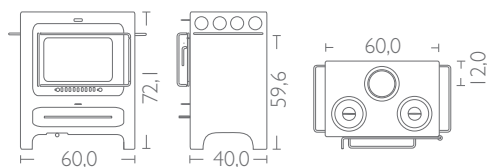

HWAM Classic 7H

Technical data

Capacity	8-14 kW
Nominal heat output	11 kW
Smoke outlet	Ø 180 mm
Net efficiency Autopilot™	79%
Chimney draught, min. (recommended)	12 Pa
Energy efficiency class Autopilot™	A

Weight

Weight	184 kg
--------	--------

Measurements

Width of combustion chamber	46,0 cm
Cooking section, H x W x D	21,9 x 45,8 x 28,7 cm
Connection from floor; top	116,6 cm

Variants

Autopilot™
Top outlet or back outlet
Cooking section door

Autopilot™



HWAM Classic 7H

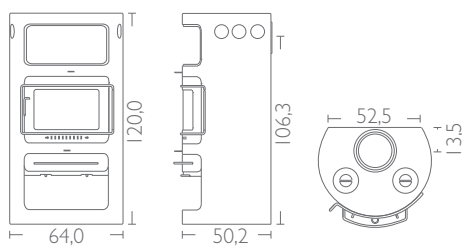

Product overview

	Nominal heat output <5 kW	Nominal heat output 5-6 kW	Nominal heat output >6 kW	HWAM® Autopilot™	HWAM® SmartControl™	Classic door	Modern door	Side hinged door	Lifting door	Side glasses	Wall-mounted	Pedestal or plinth	Heat storage compartment	Combustion air system back	Combustion air system bottom	Wood section	Soapstone cover/ Sandstone cover	White
HWAM 2610c	x			x	x	x		x		x	x	x		x	x			
HWAM 2610m	x			x	x		x	x		x	x	x		x	x			
HWAM 2620c	x			x	x	x		x			x	x		x	x			
HWAM 2620m	x			x	x		x	x			x	x		x	x			
HWAM 2630c	x			x	x	x		x		x				x	x			
HWAM 2630m	x			x	x		x	x		x				x	x			
HWAM 2640c	x			x	x	x		x						x	x			
HWAM 2640m	x			x	x		x	x						x	x			
HWAM 3110c	x			x		x		x			x	x		x	x			
HWAM 3110m	x			x			x	x			x	x		x	x			x
HWAM 3120c	x			x	x	x		x						x	x			
HWAM 3120m	x			x	x		x	x						x	x			x
HWAM 3130c	x			x	x	x		x					x	x	x			
HWAM 3130m	x			x	x		x	x					x	x	x			x
HWAM 3220c	x			x	x	x		x						x	x			
HWAM 3220m	x			x	x		x	x						x	x			
HWAM 3520c	x			x	x	x		x					x	x	x		x	
HWAM 3520m	x			x	x		x	x					x	x	x		x	
HWAM 3530c	x			x	x	x		x					x	x	x		x	
HWAM 3530m	x			x	x		x	x					x	x	x		x	
HWAM 3630c		x		x	x	x		x		x				x	x			
HWAM 3630m		x		x	x		x	x		x				x	x			x
HWAM 3640c		x		x	x	x		x						x	x		x	
HWAM 3640m		x		x	x		x	x						x	x		x	x
HWAM 3650c		x		x	x	x		x		x			x	x	x			
HWAM 3650m		x		x	x		x	x		x			x	x	x			x
HWAM 3660c		x		x	x	x		x					x	x	x		x	
HWAM 3660m		x		x	x		x	x					x	x	x		x	x

Product overview

	Nominal heat output <5 kW	Nominal heat output 5-6 kW	Nominal heat output >6 kW	HWAM® Autopilot™	HWAM® SmartControl™	Classic door	Modern door	Side hinged door	Lifting door	Side glasses	Wall-mounted	Pedestal or plinth	Heat storage compartment	Combustion air system back	Combustion air system bottom	Wood section	Soapstone cover/ Sandstone cover	White
HWAM 4510c	x			x	x	x		x		x	x	x		x	x			
HWAM 4510m	x			x	x		x	x		x	x	x		x	x			
HWAM 4520c	x			x	x	x		x			x	x		x	x			
HWAM 4520m	x			x	x		x	x			x	x		x	x			
HWAM 4530c	x			x	x	x		x		x				x	x			
HWAM 4530m	x			x	x		x	x		x				x	x			
HWAM 4540c	x			x	x	x		x						x	x		x	
HWAM 4540m	x			x	x		x	x						x	x		x	
HWAM 4550c	x			x	x	x		x		x			x	x	x			
HWAM 4550m	x			x	x		x	x		x			x	x	x			
HWAM 4560c	x			x	x	x		x					x	x	x		x	
HWAM 4560m	x			x	x		x	x					x	x	x		x	
HWAM 4620c			x	x		x		x						x	x			
HWAM 4620m			x	x			x	x						x	x			
HWAM 4640c			x	x	x	x		x						x	x		x	
HWAM 4640m			x	x	x		x	x						x	x		x	
HWAM 4660c			x	x	x	x		x					x	x	x		x	
HWAM 4660m			x	x	x		x	x					x	x	x		x	
HWAM 7150c	x			x	x	x		x					x	x	x		x	
HWAM 7150m	x			x	x		x	x					x	x	x		x	
HWAM 7180c	x			x	x	x		x					x	x	x		x	
HWAM 7180m	x			x	x		x	x					x	x	x		x	
HWAM I 30/55			x	x					x					x	x			
HWAM I 30/55s			x	x				x						x	x			
HWAM I 30/65			x	x					x					x				
HWAM Classic 4			x	x				x								x		
HWAM Classic 7H			x	x				x								x		

Distance to inflammable materials

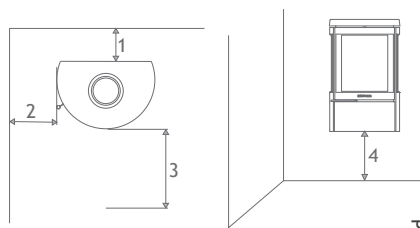

	1. Behind Cm. min.	2. Side Cm. min.	3. Distance to furnishing in front Cm. min.	4. Above inflammable floor Cm. min.	1. Distance to inflammable wall, corner location Cm. min.	2. Distance to inflammable wall, corner location Cm. min.
HWAM 2610	19	36	80	3 ⁽⁴⁾	34 ⁽³⁾	56 ⁽³⁾
HWAM 2620	19	36	80	3 ⁽⁴⁾	20 ⁽³⁾	42 ⁽³⁾
HWAM 2630	19	36	80	-	34 ⁽³⁾	56 ⁽³⁾
HWAM 2640	19	36	80	-	20 ⁽³⁾	42 ⁽³⁾
HWAM 3110	10	20	80	3 ⁽⁴⁾	13	34
HWAM 3120	10	20	80	-	13	34
HWAM 3130	10	20	80	-	13	34
HWAM 3220	10	20	80	-	13	34
HWAM 3520	10	20	80	-	13 ⁽³⁾	43 ⁽³⁾
HWAM 3530	10	20	80	-	13 ⁽³⁾	43 ⁽³⁾
HWAM 3630	10	40	90	-	35 ⁽³⁾	63 ⁽³⁾
HWAM 3640	10	40	90	-	20 ⁽³⁾	48 ⁽³⁾
HWAM 3650	10	40	90	-	35 ⁽³⁾	63 ⁽³⁾
HWAM 3660	10	40	90	-	20 ⁽³⁾	48 ⁽³⁾
HWAM 4510	10	59	120	28,5 ⁽⁶⁾	33	57
HWAM 4520	10	35	110	28,5 ⁽⁶⁾	7	31
HWAM 4530	10	59	120	-	33	57
HWAM 4540	10	35	110	-	7	31
HWAM 4540, stone cover	10	40	110	-	7	31
HWAM 4550	10	59	120	-	33	57
HWAM 4560	10	35	110	-	7	31
HWAM 4560, stone cover	10	40	110	-	7	31
HWAM 4620	7 ⁽⁵⁾ /20	40 ⁽⁵⁾ /35	130	-	12 ⁽⁵⁾ /12	41
HWAM 4640	7 ⁽⁵⁾ /20	40 ⁽⁵⁾ /35	130	-	12 ⁽⁵⁾ /12	41
HWAM 4640, stone cover	7 ⁽⁵⁾ /20	45 ⁽⁵⁾ /45	140	-	15 ⁽⁵⁾ /15	44
HWAM 4660	7 ⁽⁵⁾ /20	40 ⁽⁵⁾ /35	130	-	12 ⁽⁵⁾ /12	41
HWAM 4660, stone cover	7 ⁽⁵⁾ /20	45 ⁽⁵⁾ /45	140	-	15 ⁽⁵⁾ /15	44
HWAM 7150	5	31	80	-	5	33
HWAM 7180	5	31	80	-	5	33
HWAM I 30/55 / HWAM I 30/55s	12/6/15 ⁽¹⁾	8 ⁽²⁾	80	30	-	-
HWAM I 30/65	4/4/14 ⁽¹⁾	4 ⁽²⁾	80	30	-	-
HWAM Classic 4	10	25	80	-	10 ⁽³⁾	39 ⁽³⁾
HWAM Classic 7H	10	25	80	-	15 ⁽³⁾	43 ⁽³⁾

HWAM 2610
HWAM 2620
HWAM 2630
HWAM 2640

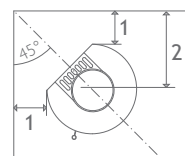

HWAM 3110
HWAM 3120
HWAM 3130

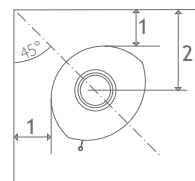

HWAM 3220

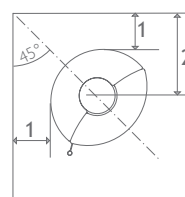

HWAM 3520
HWAM 3530

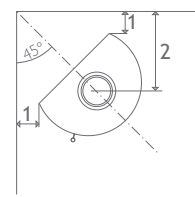

HWAM 3630
HWAM 3640
HWAM 3650
HWAM 3660

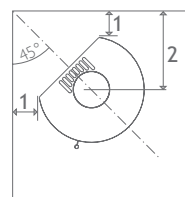

HWAM 4510
HWAM 4520
HWAM 4530
HWAM 4540
HWAM 4550
HWAM 4560

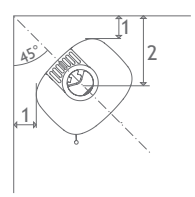

HWAM 4620
HWAM 4640
HWAM 4660

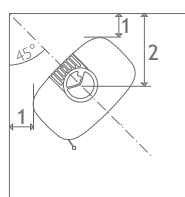

HWAM 7150
HWAM 7180

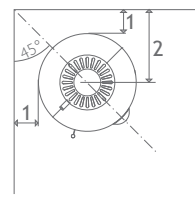

HWAM Classic 4

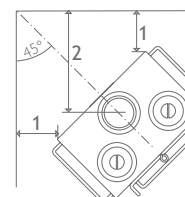

HWAM Classic 7H

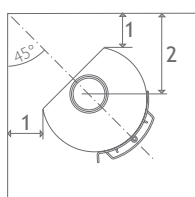

⁽¹⁾ Thickness of insulation, behind/under/over ⁽²⁾ Thickness of insulation ⁽³⁾ **Important!** All dimensions in connection with corner installation are only recommendations. Contact your chimney sweep for a clarification. ⁽⁴⁾ This distance requirement is met when the stove is mounted on a plinth. ⁽⁵⁾ with semi-insulated flue pipe (min. thickness of insulation: 35 mm) ⁽⁶⁾ This distance requirement is met when the stove is mounted on a high plinth.

Approvals



	EN 13229 (Europe)	EN 13240 (Europe)	Art. 15a (Austria)	NS 3058/3059 (Norway)	The stove announcement 2015 (Denmark)	LRV (Switzerland)	BimSchV Stufe 2 (Germany)	RLU zugelassen (Germany)	DEFRA approved (UK)	HETAS registered (UK)
HWAM 2610		x	x ⁽²⁾	x	x	x	x		x	x
HWAM 2620		x	x ⁽²⁾	x	x	x	x		x	x
HWAM 2630		x	x ⁽²⁾	x	x	x	x	x	x	x
HWAM 2640		x	x ⁽²⁾	x	x	x	x	x	x	x
HWAM 3110		x		x	x	x	x		x	x
HWAM 3120		x	x ⁽²⁾	x	x	x	x	x	x	x
HWAM 3130		x	x ⁽²⁾	x	x	x	x	x	x	x
HWAM 3220		x	x ⁽²⁾	x	x	x	x	x	x	x
HWAM 3520		x	x ⁽²⁾	x	x	x	x	x	x	
HWAM 3530		x	x ⁽²⁾	x	x	x	x	x	x	
HWAM 3630		x	x ⁽²⁾	x	x	x	x	x	x	x
HWAM 3640		x	x ⁽²⁾	x	x	x	x	x	x	x
HWAM 3650		x	x ⁽²⁾	x	x	x	x	x	x	
HWAM 3660		x	x ⁽²⁾	x	x	x	x	x	x	
HWAM 4510		x	x	x	x	x	x	x ⁽¹⁾	x ⁽¹⁾	x ⁽¹⁾
HWAM 4520		x	x	x	x	x	x	x ⁽¹⁾	x ⁽¹⁾	x ⁽¹⁾
HWAM 4530		x	x	x	x	x	x	x	x	
HWAM 4540		x	x	x	x	x	x	x	x	
HWAM 4550		x	x	x	x	x	x	x	x	
HWAM 4560		x	x	x	x	x	x	x	x	
HWAM 4620		x	x	x	x	x	x	x	x	x
HWAM 4640		x	x	x	x	x	x	x	x	x
HWAM 4660		x	x	x	x	x	x	x	x	
HWAM 7150		x	x	x	x	x	x	x		
HWAM 7180		x	x	x	x	x	x	x		
HWAM I 30/55 - HWAM I 30/55s	x			x	x	x	x		x	x
HWAM I 30/65	x				x	x				x
HWAM Classic 4		x			x ⁽³⁾	x	x			x
HWAM Classic 7H		x			x ⁽³⁾	x	x			

⁽¹⁾ Once the catalogue has been completed, we expect the finalization of the approval process, which is currently in progress.

⁽²⁾ Applies only to models with HWAM® SmartControl™.

⁽³⁾ Valid until December 2017.

NB! The table shows the status at the time of the catalogue's publication.

The current status can be obtained at any time from your HWAM dealer and can be checked on www.hwam.com

Test results

EN 13240/13229

Art. 15a

NS 3058

NS 3059

	CO at 13% O ₂	CO at 13% O ₂	Particle emission at 13% O ₂	Flue gas temperature measured in the outlet socket	Flue gas mass flow	Particle emission	CO	Particle emission
	%	mg/m ³ _n	mg/m ³ _n	°C	g/s	mg/MJ	mg/MJ	g/kg
HWAM 2610, Autopilot™	0,10	1250	22	366	3,72	-	-	3,42
HWAM 2610, SmartControl™	0,08	1000	16	372	3,55	10	654	2,20
HWAM 2620, Autopilot™	0,10	1250	22	366	3,72	-	-	3,42
HWAM 2620, SmartControl™	0,08	1000	16	372	3,55	10	654	2,20
HWAM 2630, Autopilot™	0,10	1250	22	366	3,72	-	-	3,42
HWAM 2630, SmartControl™	0,08	1000	16	372	3,55	10	654	2,20
HWAM 2640, Autopilot™	0,10	1250	22	366	3,72	-	-	3,42
HWAM 2640, SmartControl™	0,08	1000	16	372	3,55	10	654	2,20
HWAM 3110, Autopilot™	0,07	875	22	300	5,10	-	-	2,05
HWAM 3120, Autopilot™	0,07	875	22	300	5,10	-	-	2,05
HWAM 3120, SmartControl™	0,08	1000	20	307	3,66	13	630	2,45
HWAM 3130, Autopilot™	0,07	875	22	300	5,10	-	-	2,05
HWAM 3130, SmartControl™	0,08	1000	20	307	3,66	13	630	2,45
HWAM 3220, Autopilot™	0,07	875	22	300	5,10	-	-	2,05
HWAM 3220, SmartControl™	0,08	1000	20	307	3,66	13	630	2,45
HWAM 3520, Autopilot™	0,07	875	22	300	5,10	-	-	2,05
HWAM 3520, SmartControl™	0,08	1000	20	307	3,66	13	630	2,45
HWAM 3530, Autopilot™	0,07	875	22	300	5,10	-	-	2,05
HWAM 3530, SmartControl™	0,08	1000	20	307	3,66	13	630	2,45
HWAM 3630, Autopilot™	0,09	1125	18	350	6,00	-	-	1,21
HWAM 3630, SmartControl™	0,10	1250	21	325	5,04	13	756	1,78
HWAM 3640, Autopilot™	0,09	1125	18	350	6,00	-	-	1,21
HWAM 3640, SmartControl™	0,10	1250	21	325	5,04	13	756	1,78
HWAM 3650, Autopilot™	0,09	1125	18	350	6,00	-	-	1,21
HWAM 3650, SmartControl™	0,10	1250	21	325	5,04	13	756	1,78
HWAM 3660, Autopilot™	0,09	1125	18	350	6,00	-	-	1,21
HWAM 3660, SmartControl™	0,10	1250	21	325	5,04	13	756	1,78

NB! Due to the constantly development in our products the valid values may vary from the above mentioned. Updated values are available at your local HWAM dealer and can be seen on www.hwam.com.

Test results

	EN 13240/13229					Art. 15a		NS 3058 NS 3059
	CO at 13% O ₂	CO at 13% O ₂	Particle emission at 13% O ₂	Flue gas temperature measured in the outlet socket	Flue gas mass flow	Particle emission	CO	Particle emission
	%	mg/m ³ _n	mg/m ³ _n	°C	g/s	mg/MJ	mg/MJ	g/kg
HWAM 4510, Autopilot™	0,08	1000	24	312	4,1	18	752	3,01
HWAM 4510, SmartControl™	0,06	750	19	324	4,0	15	586	2,16
HWAM 4520, Autopilot™	0,08	1000	24	312	4,1	18	752	3,01
HWAM 4520, SmartControl™	0,06	750	19	324	4,0	15	586	2,16
HWAM 4530, Autopilot™	0,08	1000	24	312	4,1	18	752	3,01
HWAM 4530, SmartControl™	0,06	750	19	324	4,0	15	586	2,16
HWAM 4540, Autopilot™	0,08	1000	24	312	4,1	18	752	3,01
HWAM 4540, SmartControl™	0,06	750	19	324	4,0	15	586	2,16
HWAM 4550, Autopilot™	0,08	1000	24	312	4,1	18	752	3,01
HWAM 4550, SmartControl™	0,06	750	19	324	4,0	15	586	2,16
HWAM 4560, Autopilot™	0,08	1000	24	312	4,1	18	752	3,01
HWAM 4560, SmartControl™	0,06	750	19	324	4,0	15	586	2,16
HWAM 4620, Autopilot™	0,08	1000	28	320	5,9	19	659	1,74
HWAM 4640, Autopilot™	0,08	1000	28	320	5,9	19	659	1,74
HWAM 4640, SmartControl™	0,06	750	29	334	6,6	19	515	1,88
HWAM 4660, Autopilot™	0,08	1000	28	320	5,9	19	659	1,74
HWAM 4660, SmartControl™	0,06	750	29	334	6,6	19	515	1,88
HWAM 7150, Autopilot™	0,06	750	19	282	4,04	13	457	2,05
HWAM 7150, SmartControl™	0,07	875	19	276	4,27	14	546	2,45
HWAM 7180, Autopilot™	0,06	750	19	282	4,04	13	457	2,05
HWAM 7180, SmartControl™	0,07	875	19	276	4,27	14	546	2,45
HWAM I 30/55 - HWAM I 30/55s	0,09	1125	26	296	5,51	-	-	3,31
HWAM I 30/65	0,12	1500	28	350	9,07	-	-	-
HWAM Classic 4	0,10	1250	36	255	9,90	-	-	-
HWAM Classic 7H	0,09	1125	39	260	13,20	-	-	-

Due to the constantly development in our products the valid values may vary from the above mentioned. Updated values are available at your local HWAM dealer and can be seen on www.hwam.com.

HWAM[®] SmartStove[™]

- A whole new class of wood-burning stoves